



SECRET
DOME

www.secretdome.com



Index



P. 03

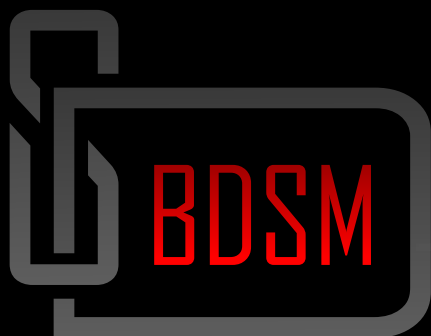

P. 15



COMING SOON



Kink^{Club} collection

Bukkake



There are more and more themed and itinerant KINKY PARTIES organized by sex clubs and individuals in private places. We offer a solution of portable cabins easy to assemble and transport that allow the organizers of these events to transform a tasteless, neutral and conventional place into a fairy and provocative space. Our cabins and accessories offer attendees a wide range of possibilities that help them to unleash their emotions and incite them to fulfill all their fantasies.

La Niche



Scandale





Bukkake



Bukkake

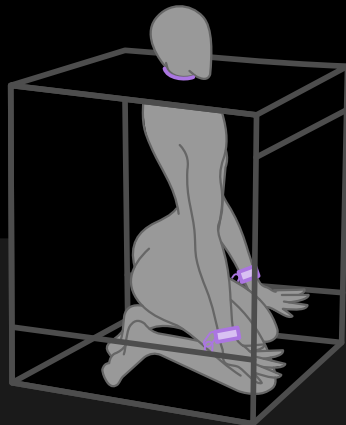
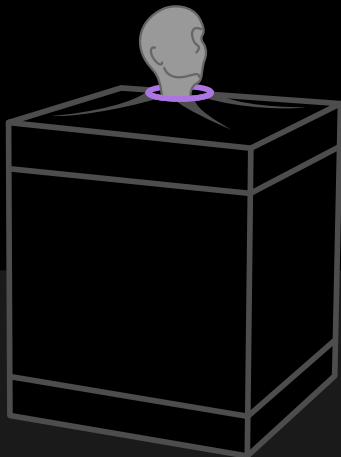
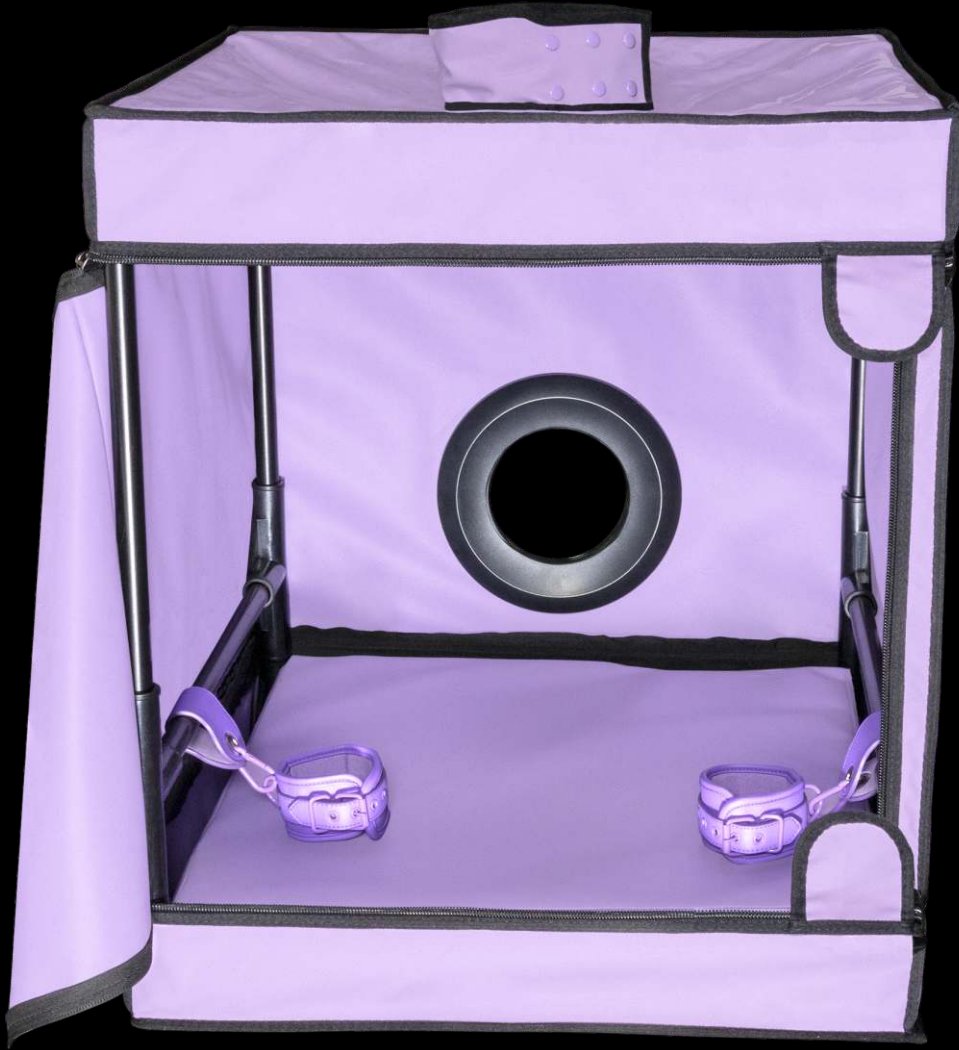

Product Specifications

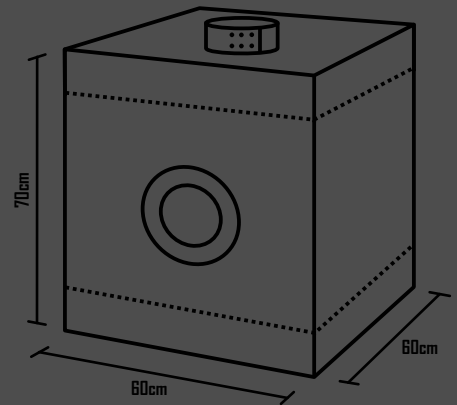

FIRE RETARDANT CONFORMITY

EN 260843 - EN 260844



COLOR SELECTION

Purple - Red & Black



Bukkake

BLACK & RED





La Niche



La Niche

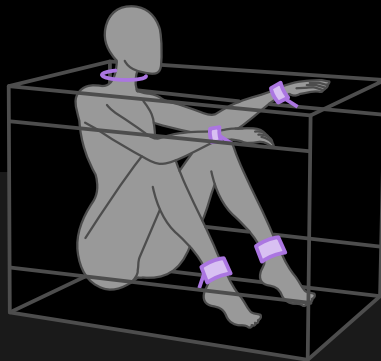
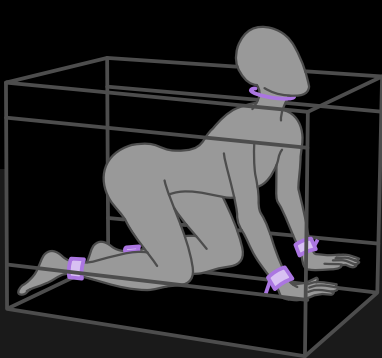
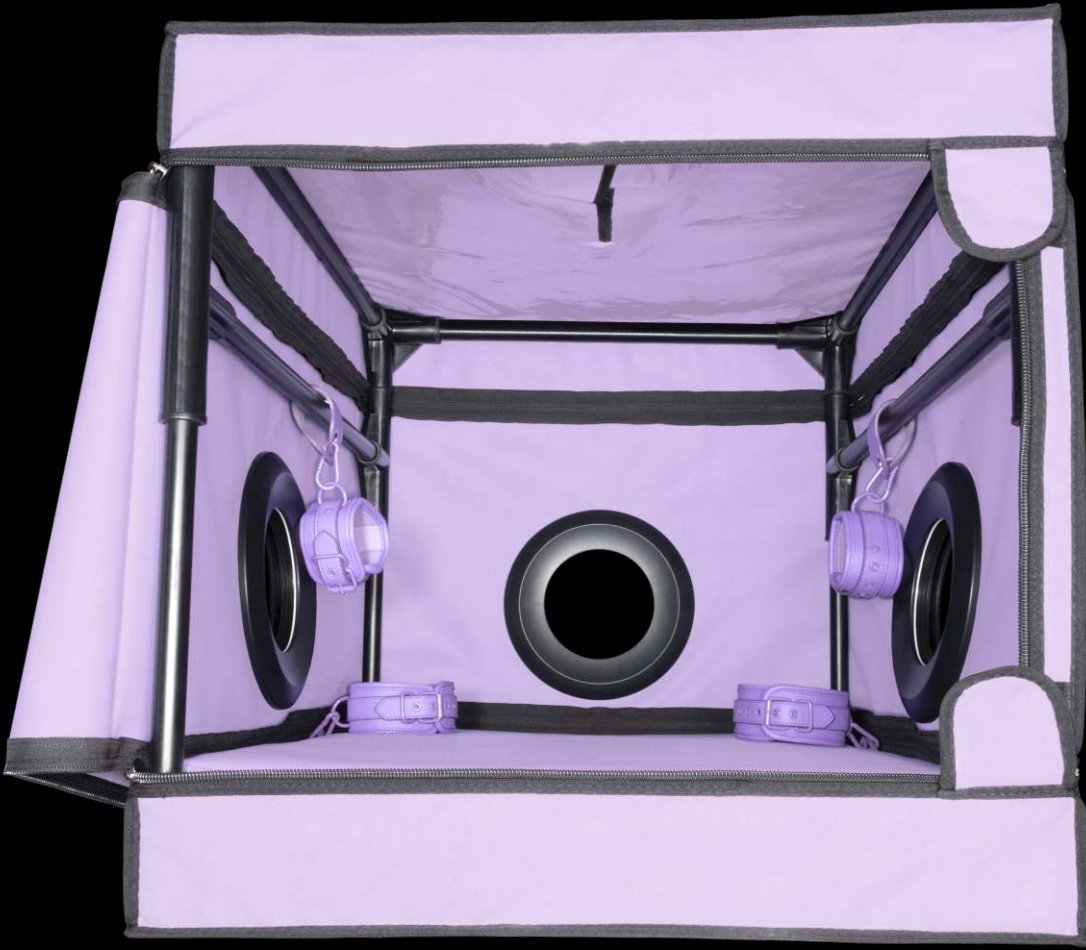

Product Specifications

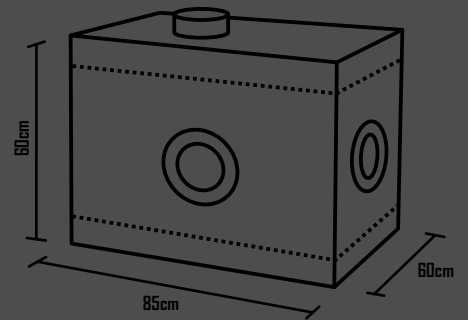

FIRE RETARDANT CONFORMITY

EN 260843 - EN 260844



COLOR SELECTION

Purple - Red & Black



La Niche

BLACK & RED





Scandale



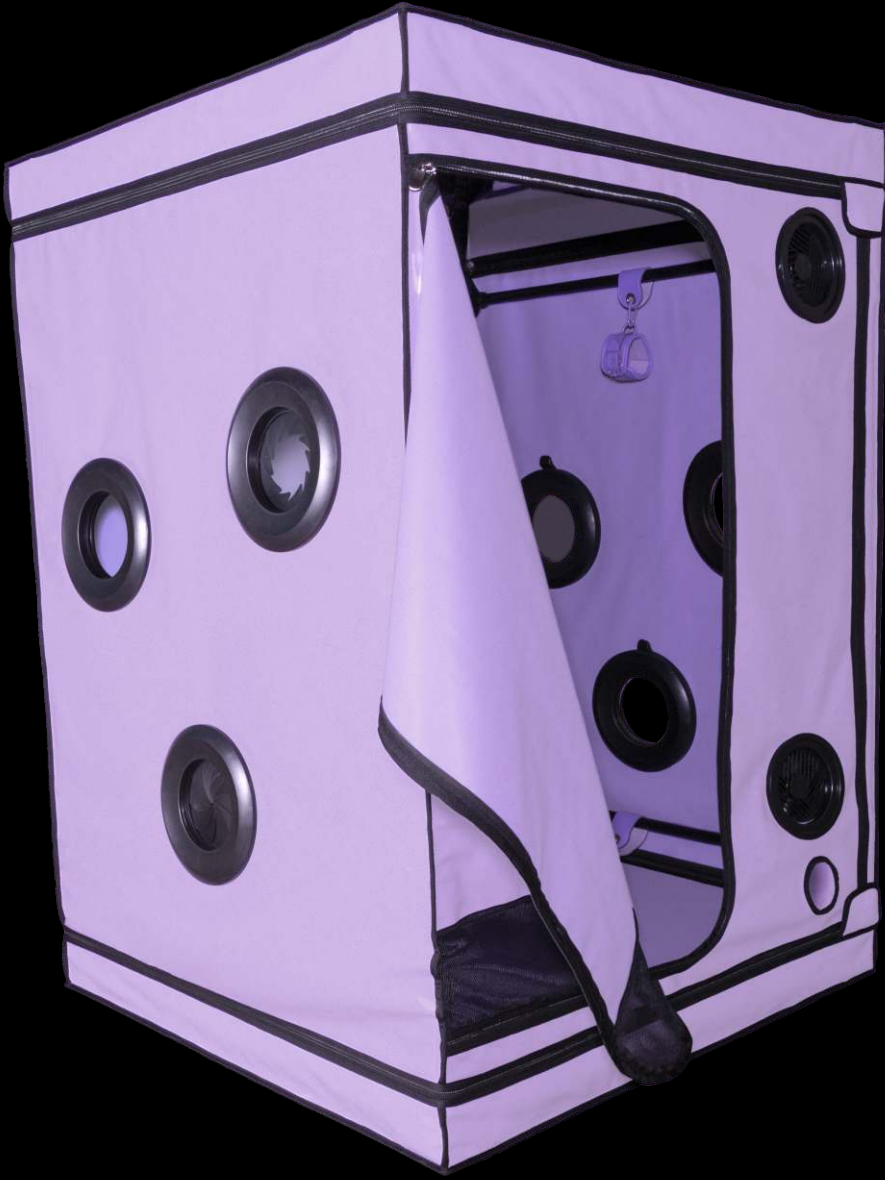

Scandale

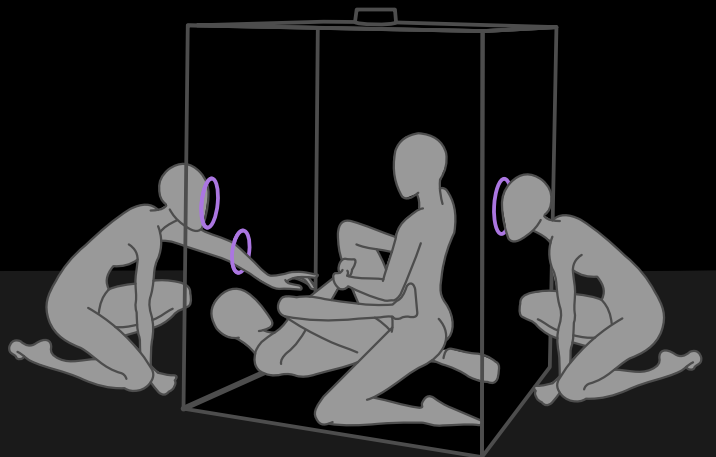
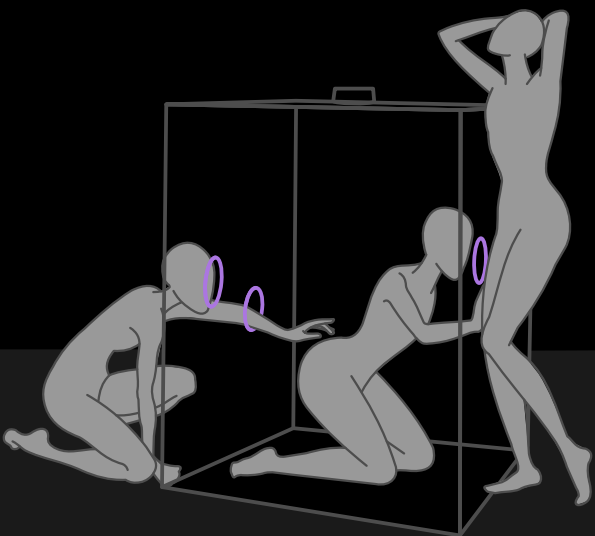

Scandale

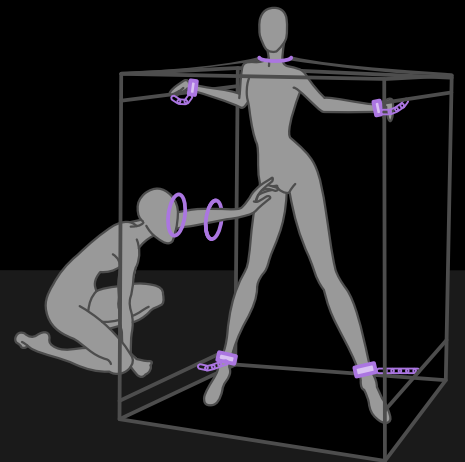
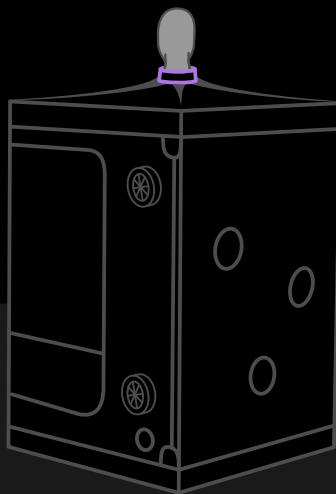
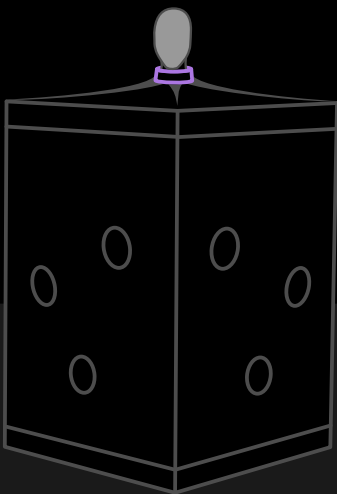
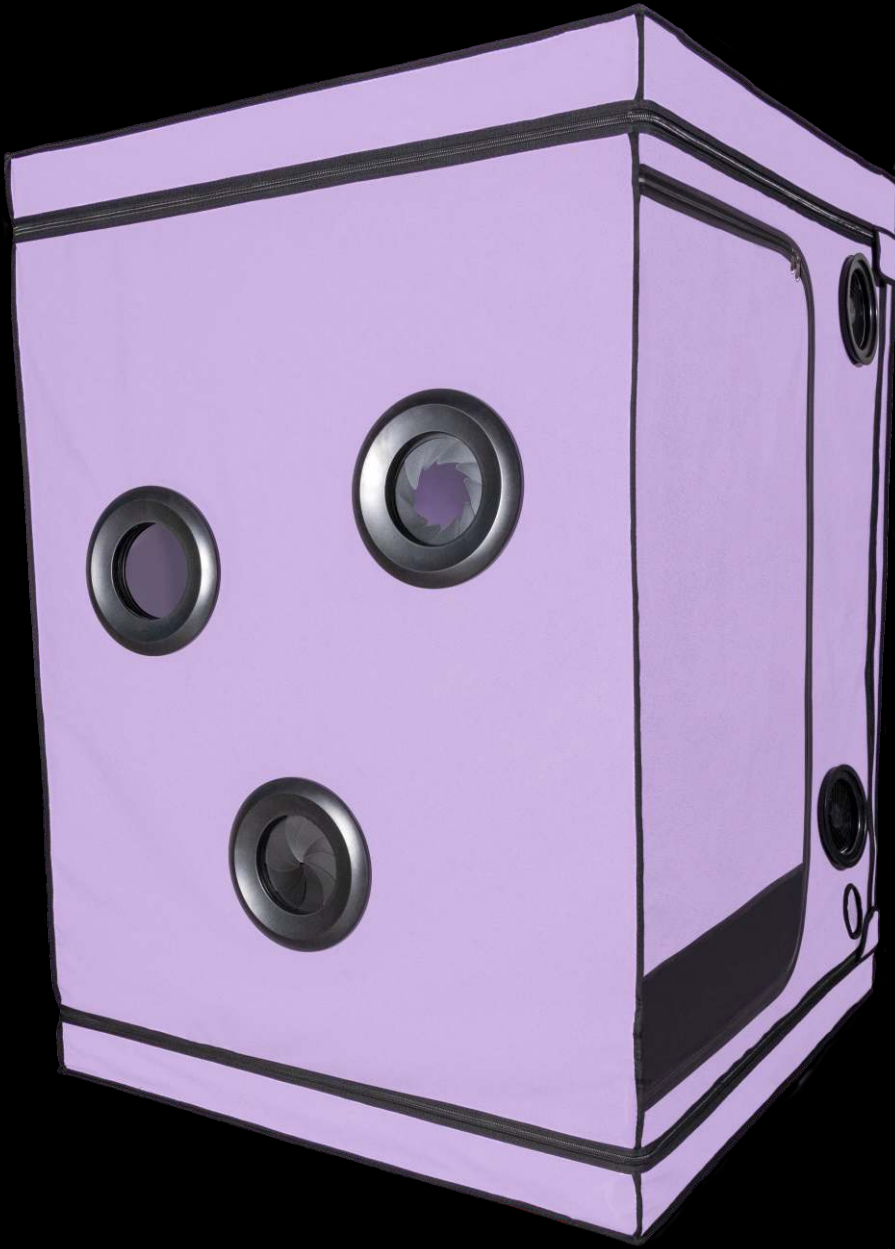

Scandale

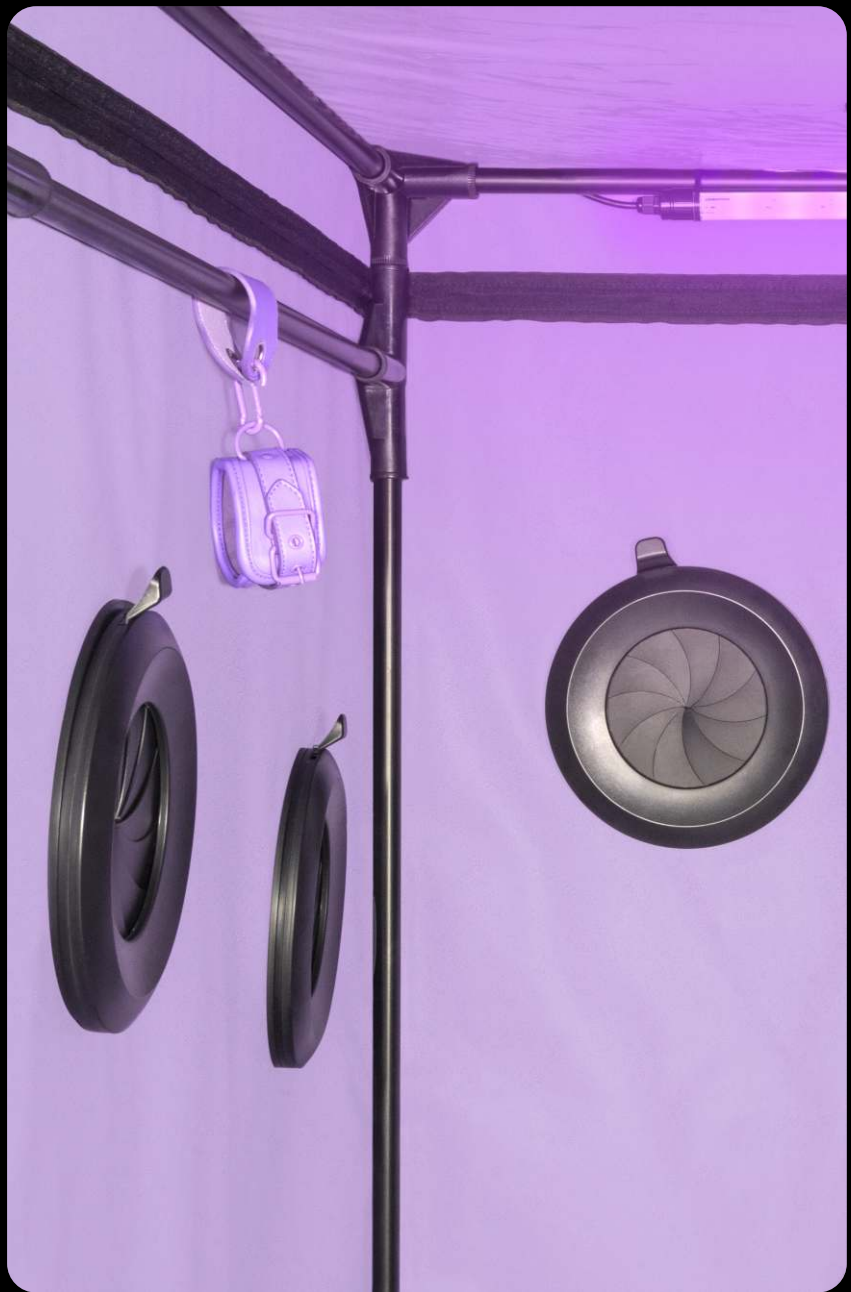

Product Specifications

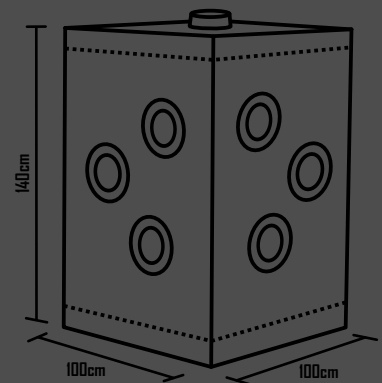

VENTILATION DEVICE / PATENT PENDING

Diameter	Power	Air Flow	Units
∅12.5cm	5W	215m ³ /h	2



FIRE RETARDANT CONFORMITY

EN 260843 - EN 260844



COLOR SELECTION

Purple - Red & Black



Scandale

BLACK & RED





BDSM

collection

Dome of Pain



We enter the world of sexual domination where pain and orgasm take on a new dimension. We offer BDSM adepts the chance to experience new sensory, acoustic and carnal sensations. We provide professionals and amateurs easy to assemble themed cabins adaptable to any environment to impose unique and innovative experiences on their submissives.



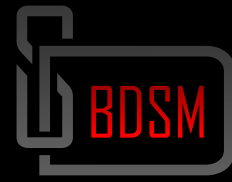

Dome of Pain

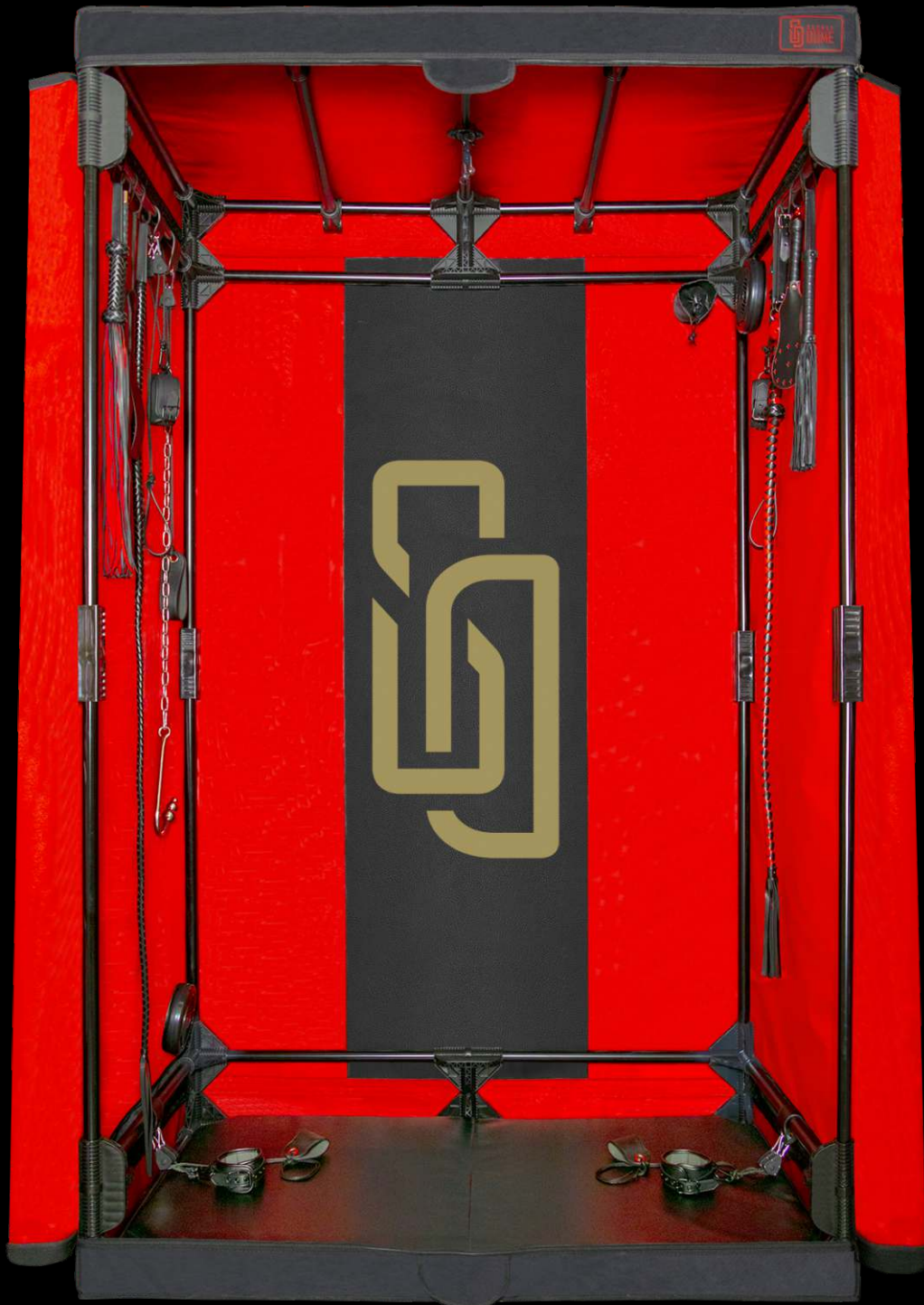



Dome of Pain

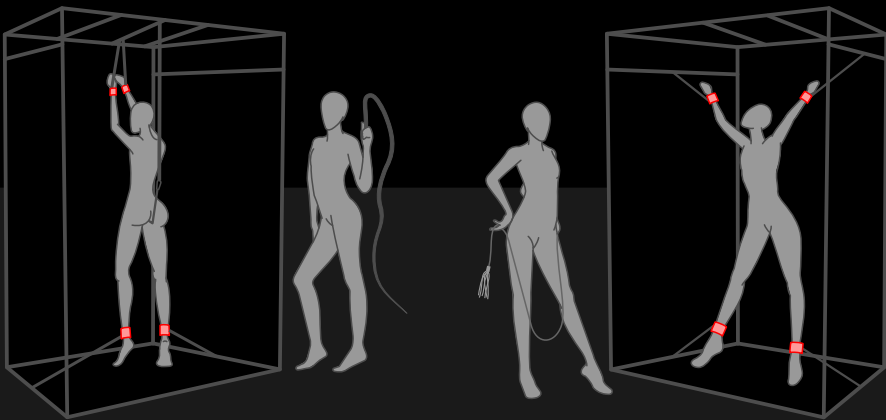

Product Specifications

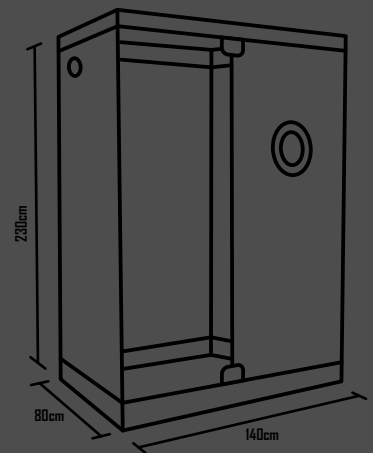

VENTILATION DEVICE / PATENT PENDING

Diameter	Power	Air Flow	Units
12.5cm	5W	215m ³ /h	2



FIRE RETARDANT CONFORMITY

EN 260843 - EN 260844

Dome of Pain





SECRET
DOME

